

3.3 Rail Select (if U2 is unstuffed, stuff R5)

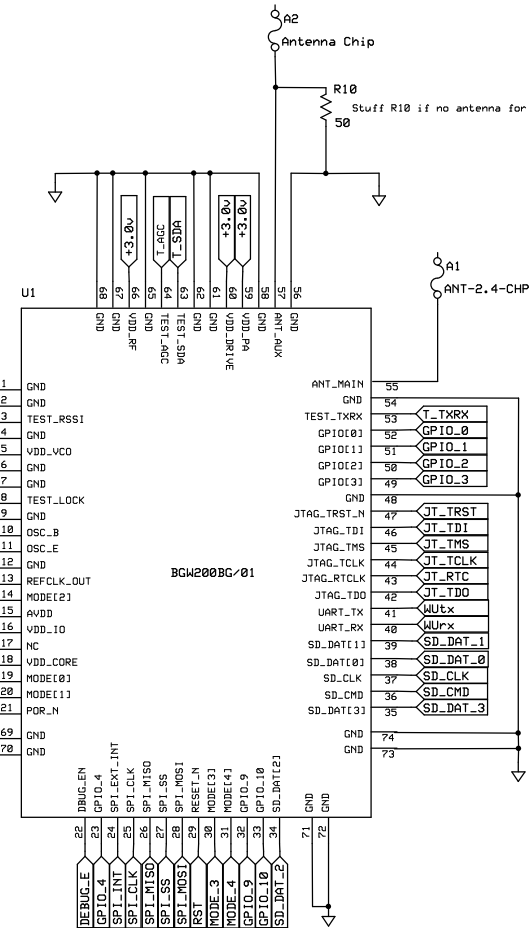
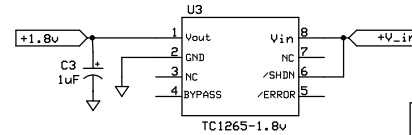
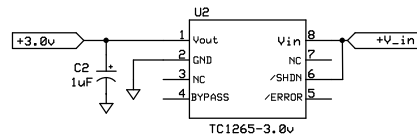
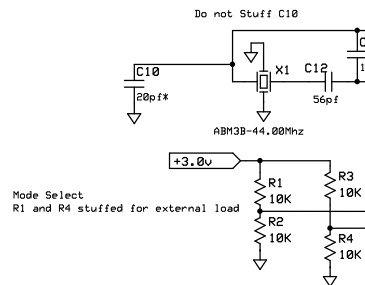
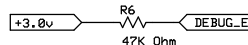
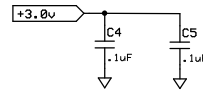
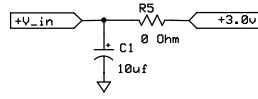

nChip (c)2006		
<b>BGW200 Wireless Module</b>		
M Johnson	Rev 1.0 7/26/2006	Page # 1 of 1